

PS14 SERIES
4-PERSON HAND WASH STATION
OPERATING INSTRUCTIONS

Height	58 in.	147 cm.
Width	22.5 in.	57 cm.
Depth	22.5 in.	57 cm.
Fresh Water Capacity	20 gal.	76 ltr.
Gray Water Capacity	22 gal.	83 ltr.
Pump Capacity (per stroke)	2 fl. oz	59.14 ml
Number of Single Dispenses	1280	1280
Weight Empty	60 lb.	27 kg.
Weight Full	226 lb.	103 kg.

Paper Towel Dispenser

Four packs of single-fold towels (Fort Howard 235-04)

235 towels per pack. 940 per wash station

Soap Dispensers

Capacity	30 fl. oz	887 ml
Total Capacity	120 fl. oz	3,548 ml

Color Options

Granite Gray, Tan, Evergreen & Army Green

We recommend reading through the entire manual prior to proceeding with maintenance or service.

TOOLS REQUIRED FOR SERVICE OR MAINTENANCE

- 5/8" Hex-key wrench
- 3/8" Hex-key wrench
- Rivet Gun
- Drill with 13/64" bit
- Standard slotted screwdriver

The plumbing system in this sink is simple and requires minimal maintenance. If the system becomes plugged, check the foot pumps first. Depress each foot pump and observe the level of resistance. If there is resistance and no water is dispensed, there is most likely an obstruction in the tube or at the orifice of the water tap spigot. If there is no resistance and no water is dispensed, then either a.) a tube connection is loose b.) an internal rubber part of the pump needs replacing. We offer two repair kits for the foot pumps:

RK-220600 (includes) - Rubber diaphragm, 2-valve springs, 2-valve seats & 2-valve flaps.

RK-220601 (includes) - 4" hose clamp, spring cap & foot spring.

Pump Removal

The base plate does not need to be removed for pump maintenance. The pumps are fastened to the base plate with four PC-000104 rivets, which will have to be drilled out to remove the pumps. Quick disconnect fittings are used throughout the plumbing system. To disconnect the tubing, pull the ring of the fitting toward the fitting stem while at the same time pulling out on the tubing.

Full Size Scale of Fasteners

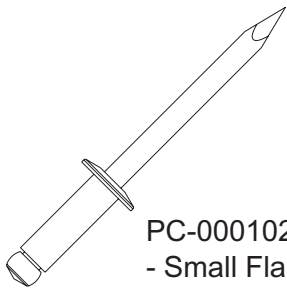

PC-000102 Rivet
- Small Flange

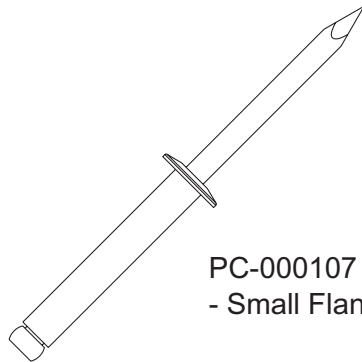

PC-000107 Rivet
- Small Flange

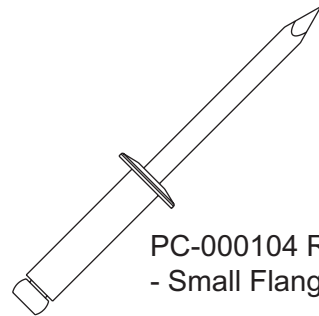

PC-000104 Rivet
- Small Flange

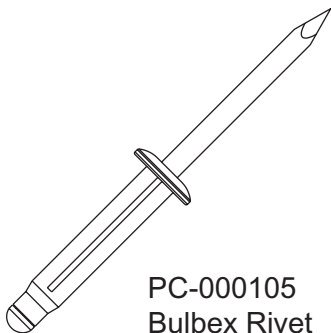

PC-000105
Bulbex Rivet

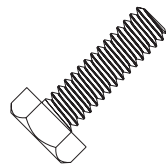

PC-000142
Hex Head Bolt

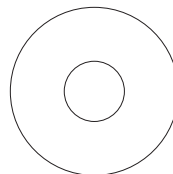

PC-000168
Flat Washer

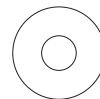

PC-000106
Back-up Washer

This self-contained, stand alone four person hand wash station is designed for use where convenient hand washing is desired or required, such as food service locations at outdoor events or construction sites. The compact design is ideal for areas where limited space is available and it is easy to transport. It features a simplified plumbing system that is easy to maintain and is supplied fully assembled.

Filling with Fresh Water

Using a 5/8" hex-key wrench, remove the 1" plug from the top corner of the sink (item # 16 on the exploded parts drawing). Insert a standard 1" garden or similar type hose and fill with a few gallons of fresh water to perform a system check. Depress each pump a few times to "prime" them. The pumps have built in check valves that will hold a prime between uses. Continue filling to 20 gallon capacity, which should take approximately 5 minutes with a standard garden hose and normal water pressure. The tank is full when you can see the water level in the 1" hole.

Paper Towel Dispenser

Unlock the master lock on the paper towel holder. Insert one pack of single fold towels (Fort Howard, No. 235-04 or equivalent) into each compartment in the towel holder body (total of 4 packs) and feed the first towel through the slots in the bottom of the towel holder body.

Soap Dispensers

See figure 2. Open the soap dispensers by placing your hands on both sides of the dispenser with your thumbs on the front approximately where the two dots are located (the tips of your thumbs should be inline with the gray top, but not on it), push in on the clear plastic while using your thumbs to "pop" the gray lid off. Locate the tab on the mounting plate at the rear of the dispenser, push in on it and slide the dispenser up and off. Fill with 30 fl. oz. of liquid soap. Refasten it to the mounting plate and snap lid back on.

Emptying Gray Water

Certain geographical areas prohibit "dumping" of gray water and require it to be properly disposed of. The gray water should be pumped-out by unscrewing the 3" cap from the top corner of the sink (item # 4 on the exploded parts drawing).

Emptying Fresh Water

Drain fresh water by removing the 1/2" plug from the bottom of the sink (item # 8 on the exploded parts drawing) with a 3/8" hex-key wrench.

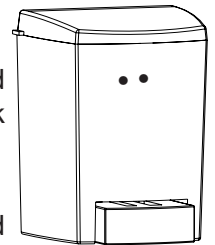

Figure 2

Access Inner Plumbing / Spigot Replacement

Drill out the eight PC-000105 bulbex rivets that attach the outer tank to the inner tower (item 7a on the exploded parts drawing). Drill out the eight PC-000107 rivets located at the spigots (item 5a on the exploded parts drawing). Pull the spigots with elbows attached out approximately 5", disconnect the tubing by pulling the ring on the fitting toward the fitting stem while at the same time pulling out on the tubing. To reattach the spigots, we recommend using PC-000117 star rivets, which eliminates the need to remove the paper towel holder to attach the PC-000106 back-up washers to the PC-000107 rivet stems. To remove the paper towel holder (item 2a on the exploded parts drawing), drill out the four PC-000105 bulbex rivets located inside the dispenser.

Drain Plumbing System

The drain system is designed to be virtually maintenance free. Each of the four sink bowls are moulded into the inner tank. Gray water drains directly into it through the three drilled holes in the bottom of each basin. These holes are kept small to minimize debris and foreign matter from entering the inner holding tank.

IMPORTANT DECALS

NOT FOR COOKING OR DRINKING, is required by law in certain areas of the U.S. Other geographical areas require that the materials used to manufacture the sinks comply with the U.S. Federal Food and Drug Administration (FDA) guidelines 21 CFR 175.300 (resins), 177.1520 (olefin polymers) and 178.3297 (colorants for polymers). The materials also comply with the U.S. Public Health Service Drinking Water Standards, 42 CFR part 72 and U.S. Environmental Protection Agency Interim Primary Drinking Water Regulations 40 CFR part 141.

HANDS FREE PUMP, instruction for user to use foot pump to operate the sink.

UNIT MUST BE DRAINED BEFORE TRANSPORTING, reminds service operator to empty the sink before transporting.